

◎Enhanced Model

MX-40PT

The MX-40PT, the enhanced MX-40QZ model, has a pet tolerance function and tamper switch.

◎DETECTION AREA

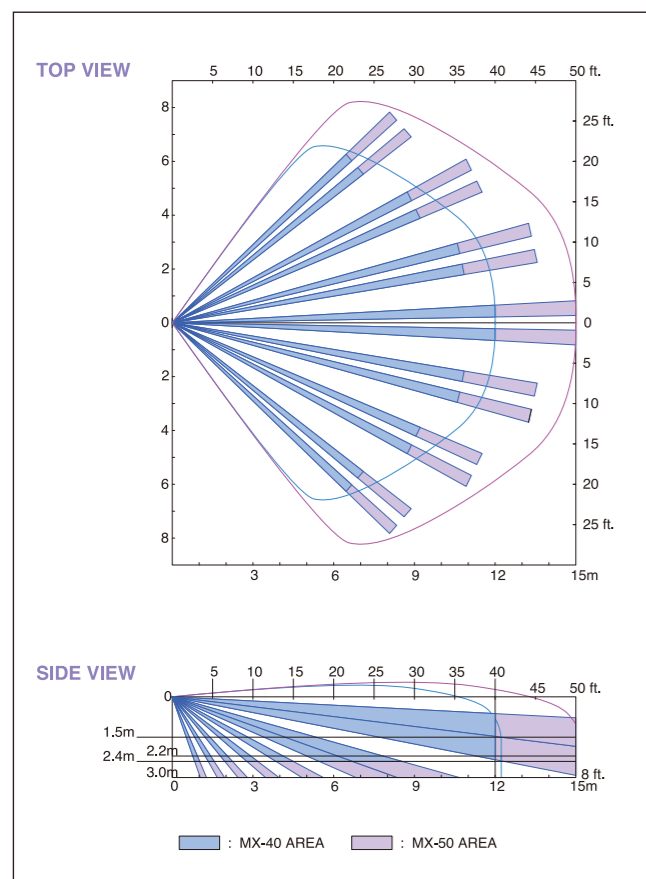

◎OPTIONAL BRACKETS

FA-3

Compact Wall & Ceiling Mount Bracket
Adjustable ±45° Horizontally,
0-10° Vertically Downwards



*Specifications and design are subject to change without prior notice.

NOTE: This unit is designed to detect movement of an intruder and activate an alarm control panel. Being only a part of a complete system, we cannot accept responsibility for any damages or other consequences resulting from an intrusion. This product conforms to the EMC Directive 89/336 EEC.



PASSIVE INFRARED & MICROWAVE
COMBINATION DETECTOR

MX-40/50



◎SPECIFICATIONS

MODEL	MX-40QZ/PT	MX-50QZ
Detection method	Passive Infrared and Microwave	
Coverage	12m x 12m (40ft. x 40ft.) 85° wide	15m x 15m (50ft. x 50ft.) 85° wide
Detection zones	78 zones (PIR)	
Mounting height	1.5 - 2.4m (5 - 8ft.)	2.2 - 3.0m (7.5 - 10ft.)
Sensitivity	2° C (3.6° F) at 0.6m/sec. (2ft./sec.)	
Detectable speed	0.3 - 1.5m/sec. (1 - 5ft./sec.)	
LED alarm indicator	Alarm condition	
Alarm period	Approx. 2.5 sec.	
Alarm output	N.C., 28V DC= 0.2A max.	
Tamper switch	N.C., Open when cover is removed (N.C., 28V DC= 0.1A max.)	
Pulse count	Approx. 20 sec. 2 or 4	
Warm up period	Approx. 1 min.	
Power supply	9.5 - 16V DC=	
Current consumption	18mA (max.) at 12V DC=	20mA (max.) at 12V DC=
Weight	110g (3.9oz.)	
Operating temperature	-10° C - +55° C (14° F - 131° F)	
Operating humidity	95% max.	
Microwave frequency	2.45GHz (FCC, IC, ETS300-440 approval)	
RF interference	No Alarm 20V/m	

◎DIMENSIONS

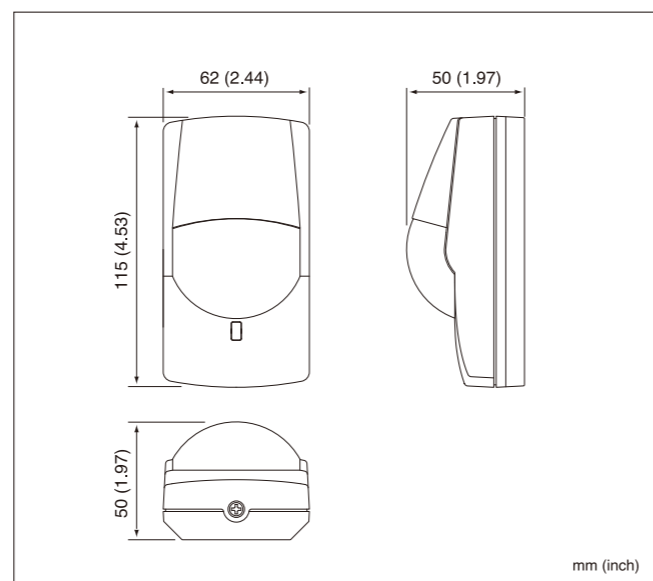

Optex Now Provides
Unprecedented Reliability in
Detection Performance by
Integrating New Microwave
Technology and Our State-
of-the-Art PIR Technology



OPTEX CO., LTD. (ISO 9001 Certified by LRQA / ISO14001 Certified by JET)
5-8-12 Ogoto, Otsu, Shiga, 520-0101 Japan
TEL +81(0)77 579 8670 FAX +81(0)77 579 8190 <http://www.optex.co.jp/e>
OPTEX INCORPORATED (USA) <http://www.optexamerica.com>
OPTEX (EUROPE) LTD. (UK) <http://www.optexuk.com>
(ISO9001 Certified by NQA)
OPTEX SECURITY SAS (FRANCE) <http://www.optex-security.com>
OPTEX KOREA CO., LTD. (KOREA) <http://www.optexkorea.com>
OPTEX SECURITY Sp. z o.o. (POLAND) <http://www.optex.com.pl>
OPTEX (DONGGUAN) CO., LTD. Shenzhen office (CHINA) <http://www.optexchina.com>
This catalogue uses paper from reforested wood in consideration of the environment. No. 75063-05-909-0807

High-Grade Sensing Performance from a Combination of Microwave and PIR Technology. Easy Installation and Compact, Attractive Design - The MX-40/50 Totally Satisfies Your Detection Needs

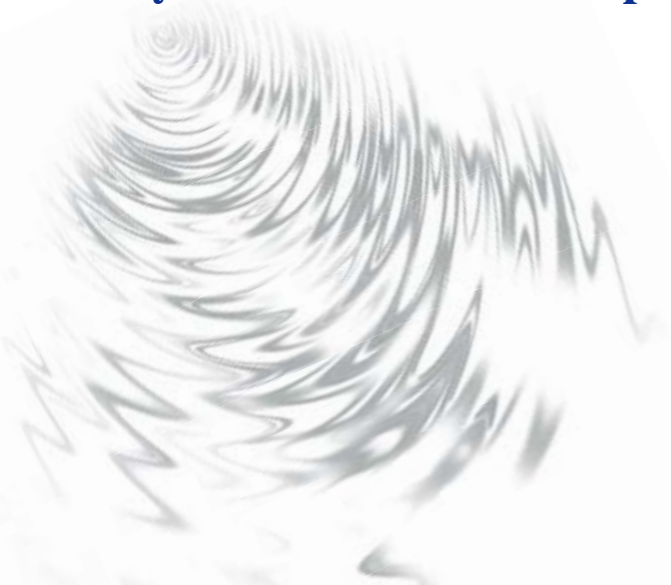

Microwave Technology

Anti-Crosstalk System

Because Optex's unique microwave technology allows the design of antenna settings differently from conventional methods, the Anti-Crosstalk System of the MX-40/50 prevents interference from other microwaves. When several detectors are placed in combination in one area, false alarms may occur due to matching frequencies, because microwaves from each detector may cause interference with each other. But the MX-40/50 greatly reduces interference to prevent false alarms. And if noise does enter the antenna and causes microwave interference, the Noise Reduction Circuit of the MX-40/50 cancels out these noises to prevent unwanted alarms. The high-quality, highly-reliable MX-40/50 solves an undeniable problem for the combination sensors – the false alarms caused by interference from other microwaves.

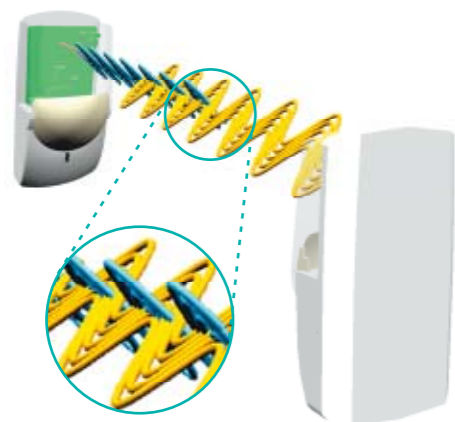

OPTEX Design and Modern Technology Quick and Easy Installation with Unique Compact Housing

- Easy installation and wiring are engineered into this compact housing.
- Easy Microwave Area Adjustment:
 - Long or Short Distance Selector Switch



Improved Performance with Reliability from Microwave and Passive Infrared Integration Optex Design and Innovation Provide High Reliability using Combination Technology

1 High Reliability

■ Ideal Detection Area

The MX-40/50 creates an integrated detection area. This enables the microwave detection area to synchronise to the PIR detection area, achieving higher detection performance and preventing errors and false alarms.

■ Spherical Lens Design

With uniform distance between each lens segment and the pyroelectric elements, the spherical lens provides a precise focal length to each of the multiple lens segments. This enables each lens segment to precisely face its detection area and creates detection zones without distortion, achieving a new level in lens design precision. Spherical design also makes lens construction tough against outside forces and highly resistant to damage from disturbances to the lens.

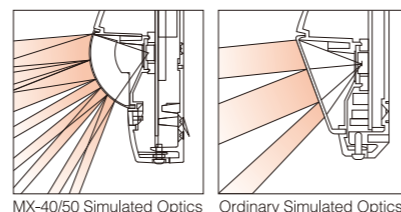

■ Noise Reduction Function

The Noise Reduction Circuit provides high-reliability performance against outside noise, such as electromagnetic interference and especially noise from fluorescent lights. False alarms are thus greatly reduced.

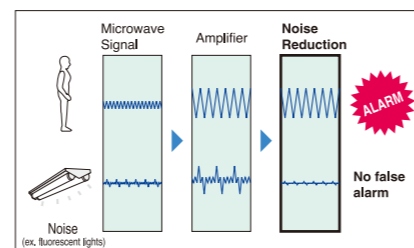

2 Easy Installation

■ Easy Microwave Range Selector

The MX-40/50 allows simple two-step adjustment. Setting the range selector to short or long-range detection sensitivity according to the room size, makes adjustment during installation much easier and less time-consuming.

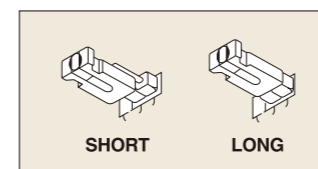

■ Easy Wiring Knockouts

The PC board is removable for simple wiring, and just by using screwdriver, a firm tap will easily remove the knockout.

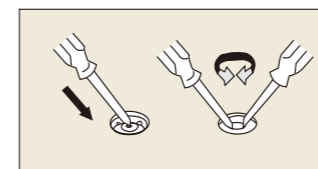

3 Compact, Stylish Design

Compact and stylish body matches any interior design without disturbing the decor.

Passive Infrared Technology

Quad Zone Logic (Patent Listed)

The highly accurate and reliable detection pattern will maintain its sensitivity through the entire detection area, even in high temperature or low contrast environments. Quad Zone Logic creates an extremely high vertical zone density, two or three times the size of conventional PIRs. These taller zones capture the entire body mass and enable detection of even the smallest temperature contrast against the background. In addition, the vertical detection density has been improved to take into account dead zones created by furniture or partitions.

